

Cariitti

VPL 30XL DALI
VPL 30XK DALI

1501524

1501525

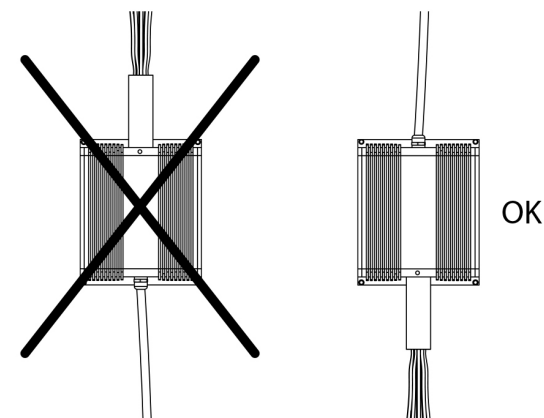
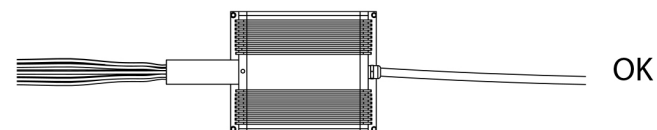
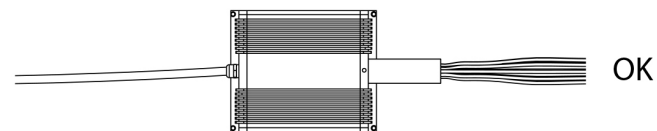
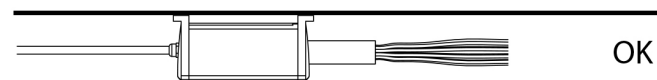
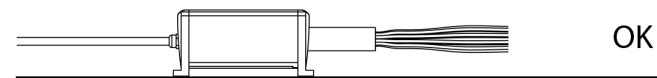
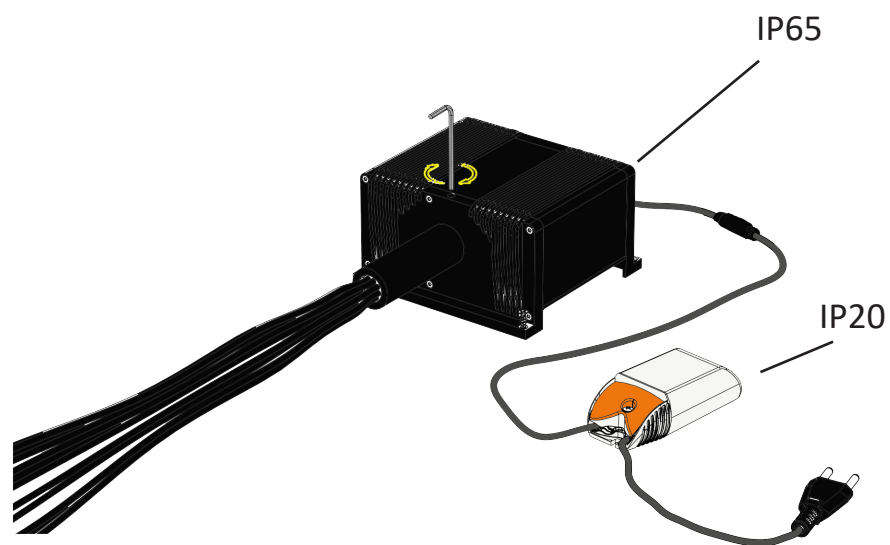
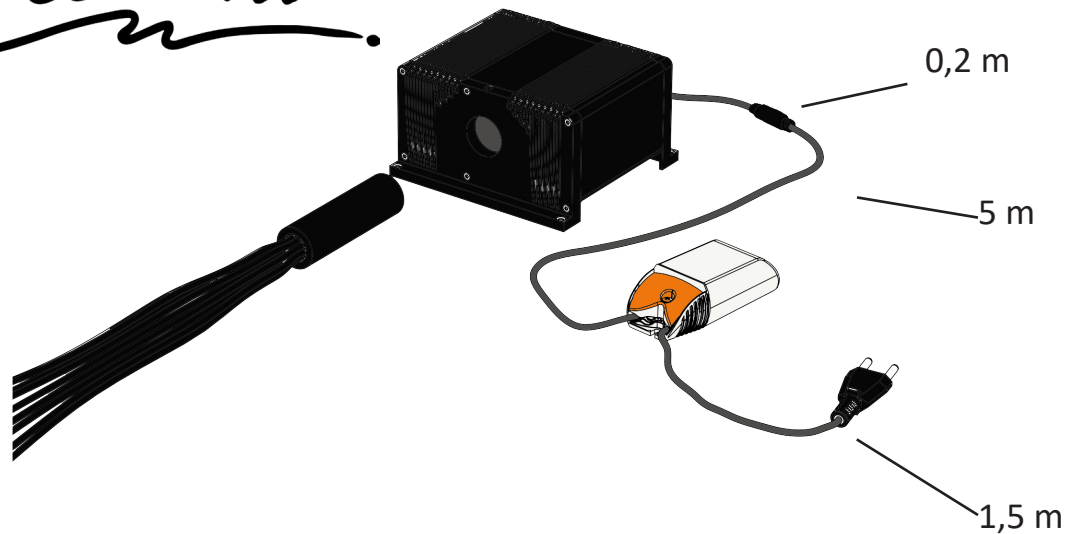

IP20 — CE EAC

Cariitti

Cariitti Oy

www.cariitti.com



Subject to change.